



oldfields

PAINTING EQUIPMENT

ADVANCE SCAFFOLD

SHEDS & STORAGE

MAKE SURE IT'S OLDFIELDS PAINTING MADE EASY

MANUFACTURING HIGH QUALITY PAINT BRUSHES,
ROLLERS & TOOLS FOR OVER 100 YEARS.



CEO WELCOME OLDFIELDS A PROUD TRADITION

Welcome and we hope you enjoy the latest product catalogue in paint accessories from Oldfields. Established in 1916, this year marks our 100th year anniversary. We are very proud to be servicing many of our long term loyal and new customers. I would like to take this opportunity to thank you for your support and for making our company what we are today and what we hope to be in the future.

Oldfields has always ensured that the best possible service is provided to all customers and trade business partners. We remain proudly Australian and our roots date back to our Founder Henry Oldfield, who was a Master brush maker. When you use an Oldfields product we always guarantee our quality, whether you are a professional or a do it yourselfer. Quality has never and will never be compromised.

Oldfields offers an extensive range of paint equipment solutions, from paint brushes, paint rollers, paint kits, buckets, poles, tools and much, much more. We now have a range of Zippy Scaffold products to compliment the trade professional and home DIY painter. Oldfields offers an unparalleled range of high quality products at value for money.

We look forward to your support and are always happy to assist wherever we can. Enjoy!

Kind Regards
Tony Grima
CEO Oldfields

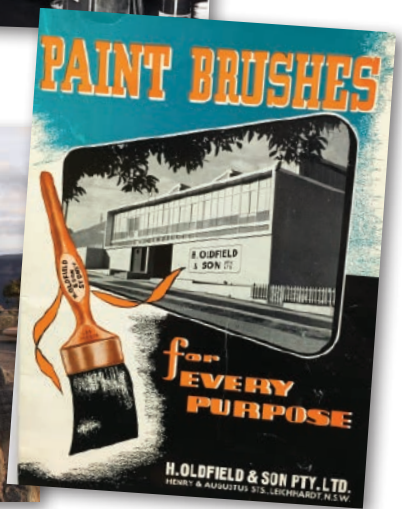

MONEY BACK GUARANTEE

If you are not 100% satisfied we will provide a full refund
"We stand behind our product"

CONTENTS

OLDFIELDS PAINTING EQUIPMENT

PAINTING EQUIPMENT

4

APPLICATION - PAINT BRUSHES - TRADESMAN	5
APPLICATION - PAINT BRUSHES - SUPERFECT	6
APPLICATION - PAINT BRUSHES - PROFESSIONAL	7
APPLICATION - PAINT BRUSHES - ECO	8
APPLICATION - PAINT BRUSHES - INDUSTRIAL	9
APPLICATION - PAINT BRUSHES - SPECIALTY	10-11
APPLICATION - PAINT BRUSHES - ARTIST	12
APPLICATION - ROLLER COVERS - PRO SERIES	14-15
APPLICATION - ROLLER COVERS - SHEEPSKIN	16
APPLICATION - ROLLER COVERS - CLASSIC	17
APPLICATION - ROLLER COVERS - TEXTURE	18
APPLICATION - ROLLER COVERS - ECONOMY & FOAM	19
APPLICATION - MINI ROLLERS & FRAMES	20
APPLICATION - ROLLER KITS	21-22
APPLICATION - EXTENSION POLES	23
APPLICATION - PAINT POT	25
APPLICATION - PAINTERS BUCKETS	26
APPLICATION - ROLLER TRAYS	27
APPLICATION - SHEEPSKIN MITTS	28
APPLICATION - DECKING - SHEEPSKIN APPLICATOR	29
APPLICATION - STRAIGHT LINE EDGER	30
APPLICATION - PAINT PADS	31
APPLICATION - WALLPAPER	32
PROTECTION - DROP CLOTHS - SAFETY	34
PROTECTION - DROP CLOTHS - CANVAS HEAVY DUTY	35
PROTECTION - COVERALLS, TAPES & RAGS	36
PAINT TOOLS - CAULKING GUNS	38
PAINT TOOLS - SCRAPERS - CRAFTSMAN	39
PAINT TOOLS - SCRAPERS - SOFT GRIP	40
PAINT TOOLS - SCRAPERS - GENERAL PURPOSE	41
PAINT TOOLS - STRIPPING KNIVES	42
PAINT TOOLS - HEAVY DUTY SCRAPER - LINBIDE	43
PAINT TOOLS - SAFETY SCRAPERS	44
PAINT TOOLS - PREPARATION - ABRASIVES	45
PAINT TOOLS - MIXERS - WACKERS - PADDLES	46
OLDFIELDS PROMOTIONAL PACKS	47

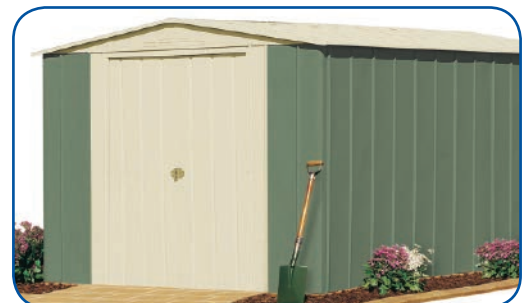

SHEDS & STORAGE

48

OLDFIELDS SHEDS & STORAGE	49
SHEDS & STORAGE - GABLE ROOF SHEDS	50
SHEDS & STORAGE - EXTRA HEIGHT / WORKSHOP SHEDS	51
SHEDS & STORAGE - UTILITY SHEDS	52
SHEDS & STORAGE - STORE SMART & FLAT ROOF SHEDS	53

SCAFFOLDING

54

OLDFIELDS SCAFFOLDING	55
OLDFIELDS SCAFFOLDING - Zippy-Scaff Aluminium	56
OLDFIELDS SCAFFOLDING - Zippy-Scaff Fibreglass	57
OLDFIELDS SCAFFOLDING - Mini Foldable Scaffold	58



A PREMIUM BRUSH A PREMIUM FINISH



OLDFIELDS ADVANCED SYNTHETIC TRADESMAN The Master Painter's Choice!

A **superior** brush for the professional trade painter who needs maximum performance, durability & longevity. Featuring Advanced Synthetic filament; a longer & fuller filament that holds more paint providing continuous, smooth & even coverage. The capacity of the brush to maintain its shape & performance after continuous use is excellent. Tapered ends & slimline design provides a smooth & accurate finish.



DESCRIPTION	SIZE	VPN	MOQ	CTN QTY	BARCODE
WALL BRUSH	38mm	21138	1pc	6pcs	9313290093739
	50mm	21150	1pc	6pcs	9313290093722
	63mm	21163	1pc	6pcs	9313290093715
	75mm	21175	1pc	6pcs	9313290093708
	88mm	21188	1pc	6pcs	9313290093692
SASH CUTTER	50mm	21250	1pc	6pcs	9313290093777
	63mm	21263	1pc	6pcs	9313290093760
ANGLE CUTTER	50mm	21350	1pc	6pcs	9313290093807
	63mm	21363	1pc	6pcs	9313290093791
OVAL CUTTER	50mm	21450	1pc	6pcs	9313290093821
	63mm	21463	1pc	6pcs	9313290093814

FEATURES:



- > Maximum performance
- > Use with all paints
- > Use on all surfaces



- > Advanced technology
- > Holds more paint
- > Faster coverage



- > Smooth finish
- > Hard wearing
- > More accuracy



- > Light & comfortable
- > Easy to use
- > Fast easy clean



- > Shape recovery
- > Long term use
- > No filament loss
- > Reusable packaging



USE WITH
ALL PAINTS

OLDFIELDS ALL PURPOSE SYNTHETIC SUPERFECT

The Superfect range has been created as an all purpose brush to be used with all paints on all surfaces. Featuring Fast Flow Technology, the Superfect is a great quality brush that can be used on multiple projects providing a quality finish.



DESCRIPTION	SIZE	VPN	MOQ	CTN QTY	BARCODE
WALL BRUSH	25mm	24125	1pc	6pcs	9313290095405
	38mm	24138	1pc	6pcs	9313290095412
	50mm	24150	1pc	6pcs	9313290095429
	63mm	24163	1pc	6pcs	9313290095436
	75mm	24175	1pc	6pcs	9313290095443
	88mm	24188	1pc	6pcs	9313290095450
SASH CUTTER	50mm	24250	1pc	6pcs	9313290095467
	63mm	24263	1pc	6pcs	9313290095474
ANGLE CUTTER	50mm	24350	1pc	6pcs	9313290095481
	63mm	24363	1pc	6pcs	9313290095498
OVAL CUTTER	50mm	24450	1pc	6pcs	9313290095504
	63mm	24463	1pc	6pcs	9313290095511

FEATURES:



- > Fast flow technology
- > Holds more paint
- > Faster coverage



- > Smooth finish
- > More accuracy



- > Light & comfortable
- > Easy to use
- > Fast easy clean



- > Shape recovery
- > Long term use
- > No filament loss
- > Reusable packaging
- > Unpainted timber handle



USE WITH
ALL PAINTS

OLDFIELDS PURE BRISTLE BRUSHES

Featuring the very finest premium hog bristles. Meticulously crafted and fully flagged for a smooth & even paint finish. Best with oil based paints & good with all paints. This brush is for the traditional painter who requires a long lasting, durable & professional quality finish to every paint job.



27738

27750

15025

15038

15050

15063

15075

FEATURES:

DESCRIPTION	SIZE	VPN	MOQ	CTN QTY	BARCODE
WALL BRUSH	25mm	15025	1pc	12pcs	9310590150254
	38mm	15038	1pc	12pcs	9310590150384
	50mm	15050	1pc	12pcs	9310590150506
	63mm	15063	1pc	12pcs	9310590150636
	75mm	15075	1pc	6pcs	9310590150759
SIGN CUTTER PRO CUTTER	38mm	27738	1pc	6pcs	9310590277388
	50mm	27750	1pc	6pcs	9310590277500



- > Maintains shape
- > Long term use
- > No filament loss



- > Holds more paint
- > Faster coverage
- > Easy to clean



- > Light & comfortable
- > Easy to use
- > Reusable packaging



USE WITH
OIL PAINTS

OLDFIELDS ECO RANGE



Recycled
bamboo handle
& packaging

Oldfields ECO brush range is in your choice for quality paint accessories that have minimal impact on the environment. Designed to be gentler on the environment by using either biodegradable or recycled materials where possible, to ensure that your paint job will have a minimal carbon footprint on the earth.



13925

13938

13950

13963

13975

139100



FEATURES:



> Environmentally Friendly



> Maintains shape
> Long term use
> Easy to clean



> Light & comfortable
> Easy to us



USE WITH
ALL PAINTS

DESCRIPTION	SIZE	VPN	MOQ	CTN QTY	BARCODE
WALL BRUSH ECO CHOICE > Polyester Filament > Stainless Steel Ferrule	25mm	13925	1pc	6pcs	9310590139259
	38mm	13938	1pc	6pcs	9310590139389
	50mm	13950	1pc	6pcs	9310590139501
	63mm	13963	1pc	6pcs	9310590139631
	75mm	13975	1pc	6pcs	9310590139754
	100mm	139100	1pc	6pcs	9310590139044

OLDFIELDS INDUSTRIAL RANGE

All purpose brushes that are ideal for all types of paints & varnishes for everyday use. Economically priced, high value bristle & synthetic blends, designed to achieve a quality finish.

DESCRIPTION	SIZE	VPN	MOQ	CTN QTY	BARCODE
RED LINE WALL BRUSH > Full length > Synthetic filament > Stainless steel ferrule > Painted timber handle > Reusable Packaging	25mm	14725	1pc	12pcs	9310590147254
	38mm	14738	1pc	12pcs	9310590147384
	50mm	14750	1pc	12pcs	9310590147506
	75mm	14775	1pc	12pcs	9310590147759
	100mm	147100	1pc	6pcs	9310590147049
CHIP BRUSHES > Short length > 100% White pure bristle > Set in epoxy > Ideal for applying fibreglass, glues & resins > No coating on handle to be affected by resins or solvents.	12mm	16412	1pc	36pcs	9310590164121
	25mm	16425	1pc	36pcs	9310590164251
	38mm	16438	1pc	36pcs	9310590164381
	50mm	16450	1pc	36pcs	9310590164503
	75mm	16475	1pc	12pcs	9310590164756
	100mm	164100	1pc	6pcs	9310590164046
INDUSTRIAL RANGE BRUSHES > 100% pure black bristle > Set in epoxy > Ideal for fibreglass & industrial jobs > Unpainted timber handle	12mm	40412	1pc	6pcs	9310590404128
	25mm	40425	1pc	6pcs	9310590404258
	50mm	40450	1pc	6pcs	9310590404500
	75mm	40475	1pc	6pcs	9310590404753

RED LINE BRUSHES - SYNTHETIC



14725 14738 14750 14775 147100

CHIP BRUSHES - PURE BRISTLE



16412 16425 16438 16450 16475 164100

INDUSTRIAL RANGE



40412 40425 40450 40475

OLDFIELDS SPECIALTY BRUSHES

Oldfields specialty brushes are ideal for the painter needing a quality brush for unique job applications. They can get into hard to reach areas, used for more controlled smaller touch-ups & are economical, hard wearing & easy to clean.

DESCRIPTION	SIZE	VPN	MOQ	CTN QTY	BARCODE
LINING FITCHES > Premium quality > Synthetic > Handcrafted > Controlled Coverage > Economical > Perfect for Touch-ups	6mm	20306	1pc	12pcs	9310590203066
	12mm	20312	1pc	12pcs	9310590203127
	18mm	20318	1pc	12pcs	9310590203189
	25mm	20325	1pc	12pcs	9310590203257
	Mixed 9 Pk	FITCH-PACK-F	1pk	1pk	9310590203387
LINING FITCHES > Premium quality > 100% Pure Bristle > Handcrafted > Controlled Coverage > Economical > Perfect for Touch-ups	6mm	20106	1pc	12pcs	9310590201062
	12mm	20112	1pc	12pcs	9310590201123
	18mm	20118	1pc	12pcs	9310590201185
	25mm	20125	1pc	12pcs	9310590201253
	Mixed 9 PK	FITCH-PACK	1pk	1pk	9310590203394
RADIATOR BRUSH > Bent plastic handle > 100% Pure bristle > Ideal for painting hard to reach areas. > Good paint release	25mm	50610	12pcs	12pcs	9311721506100
	38mm	50615	12pcs	12pcs	9311721506155
	50mm	50620	12pcs	12pcs	9311721506209
OFFSET BRUSH > Bent Wooden handle > 100% Pure bristle > Ideal for painting hard to reach areas. > Good paint release	38mm	15938	12pcs	12pcs	9310590159387
	50mm	15950	12pcs	12pcs	9310590159509
ROBO FLATS > 100% Pure Bristle > Plastic handle > Economical Only available in Box Quantities	25mm	40110	36pcs	36pcs	9311721401108
	38mm	40115	36pcs	36pcs	9311721401153
	45mm	40120	36pcs	36pcs	9311721401207



FITCHPACK & FITCHPACK-F
 9 Pack Lining Fitch brushes
 3 each of 12mm, 18mm & 25mm



LINING FITCH
 SYNTHETIC



PURE BRISTLE



OFFSET WOOD



OFFSET PLASTIC



ROBO FLATS



USE WITH
 ALL PAINTS

OLDFIELDS SPECIALTY BRUSHES

A brush for every project with premium quality synthetic and bristle filament.



PAINTERS DUSTER
104100

EFFECTS BRUSH
155120



FENCE & DECKING BRUSH
156100



SASH TOOL - PLASTIC



SASH TOOL - WOODEN



ACID BRUSH
2006

DESCRIPTION	SIZE	VPN	MOQ	CTN QTY	BARCODE
EFFECTS BRUSH > Synthetic Filament. Use with suede, metallic, texture or other decorative finish paints	120mm	155120	1pc	6pcs	9310590155051
FENCE & DECK BRUSH > Synthetic filament > Maximum width ensures max coverage with minimal effort	100mm	156100	1pc	12pca	9310590156041
SASH TOOL > Plastic handle > Pure Bristle	#4 16mm	51704	1pc	6pcs	9311721517045
	#6 18mm	51706	1pc	6pcs	9311721517069
	#8 25mm	51708	1pc	6pcs	9311721517083
SASH TOOL > Wooden handle > Pure Bristle	#2 10mm	7002	1pc	6pcs	9310590070026
	#6 18mm	7006	1pc	6pcs	9310590070064
	#8 25mm	7008	1pc	6pcs	9310590070088
	#12 30mm	7012	1pc	6pcs	9310590070125
ACID BRUSH > Tampico fibre > For white wash & acids	2 Knot 6oz	2006	1pc	6pcs	9310590020069
PAINTERS DUSTER > Pure bristle 4 knot > Aluminium ferrule	100mm	104100	1pc	6pcs	9310590104042
POCKET DUSTER > Pure bristle	170mm	105180	1pc	12pcs	9310590105070

FEATURES:



- > Maintains shape
- > Long term use
- > No filament loss



- > Holds more paint
- > Faster coverage
- > Easy to clean



- > Light & comfortable
- > Easy to use



USE WITH
ALL PAINTS

OLDFIELDS ARTIST BRUSHES

“A Quality Brush for a Quality Finish”

DESCRIPTION	SIZE	VPN	MOQ	CTN QTY	BARCODE
FLAT TIP - 577 BRUSHES > 100% white pure bristle > Allows more paint to be carried, lengthening the stroke > Used for coverage > Maintain a razor sharp edge. > Only available in carton quantities	#2 4.9mm	5772	12pcs	12pcs	9310590577204
	#4 6.0mm	5774	12pcs	12pcs	9310590577402
	#6 7.2mm	5776	12pcs	12pcs	9310590577600
	#8 10.1mm	5778	12pcs	12pcs	9310590577808
	#10 10.8mm	57710	12pcs	12pcs	9310590577105
	#12 11.5mm	57712	12pcs	12pcs	9310590577129
	1 card of 4	577CARD	12pcs	24pcs	9310590577006
ROUND FITCH - 777 BRUSHES > 100% white pure bristle > Used for detailed painting > Maintain its shape for accuracy > Only available in carton quantities	#2 3.4mm	7772	12pcs	12pcs	9310590777208
	#4 6.0mm	7774	12pcs	12pcs	9310590777406
	#6 8.1mm	7776	12pcs	12pcs	9310590777604
	#8 9.3mm	7778	12pcs	12pcs	9310590777802
	#10 12.0mm	77710	12pcs	12pcs	9310590777109
	#12 14.5mm	77712	12pcs	12pcs	9310590777123
TOUCH UP - 111 BRUSHES > Soft hair > Broad coverage > Reduces the requirement to switch brushes > Only available in carton quantities	#2 2.5mm	11102	12pcs	12pcs	9310590111026
	#4 3.5mm	11104	12pcs	12pcs	9310590111040
	#6 4mm	11106	12pcs	12pcs	9310590111064
	#8 5.0mm	11108	12pcs	12pcs	9310590111088
	#10 6.0mm	11110	12pcs	12pcs	9310590111101
	#12 8.0mm	11112	12pcs	12pcs	9310590111125



577CARD



FLAT TIP - 577 SERIES



ROUND TIP - 777 SERIES



TOUCH UP - 111 SERIES

FEATURES:



- > Maintains shape
- > Long term use
- > No filament loss



- > Light & comfortable
- > Easy to use
- > Easy to clean



USE WITH
ALL PAINTS

FOLLOW THE LEADER



OLDFIELDS PRO SERIES ROLLER COVERS

PREMIUM QUALITY - The Professional Choice

Ideal for an extremely fine and smooth finish, these rollers are made from high quality woven polyester to provide maximum durability & maximum hold. The Pro Series provides superior quality results every time.



625



618



611



619



612

DESCRIPTION	SIZE	VPN	MOQ	CTN QTY	BARCODE
WOVEN POLYESTER 32mm SUPER Nap > ideal with water based paints on rough timber, bricks, rendered & textured surfaces	230mm	625	1pc	60pcs	9310590006254
	270mm	626	1pc	60pcs	9310590006261
	360mm	627	1pc	40pcs	9310590006278
WOVEN POLYESTER 22mm LONG Nap > ideal with water based paints on walls, ceilings rendered & textured surfaces	230mm	618	1pc	96pcs	9310590006186
	270mm	619	1pc	96pcs	9310590006193
	270mm	619 TWIN	1pc	48pca	9310590061925
	270mm	619-3	1pc	32pcs	9310590619034
	360mm	620	1pc	48pcs	9310590006209
	460mm	621	1pc	20pcs	9310590006216
WOVEN POLYESTER 11mm REGULAR Nap > ideal with water based paints on smooth and semi-smooth walls & ceilings	230mm	611	1pc	120pcs	9310590006117
	270mm	612	1pc	120pcs	9310590006124
	270mm	612 TWIN	1pc	60pca	9310590061222
	270mm	612-3	1pc	40pca	9310590061239
	360mm	613	1pc	60pcs	9310590006131
	460mm	614	1pc	54pcs	9310590006148

FEATURES:

- > Maximum durability & paint hold
- > Best quality fabric from USA
- > Fast, smooth & even coverage on all surfaces
- > Good pick-up and release
- > Easy to clean and re-use
- > Thick phenolic core



**USE WITH
ALL PAINTS**

OLDFIELDS PRO SERIES ROLLER COVERS

PREMIUM QUALITY - The Professional Choice



Oldfields Pro Series covers are made from high quality fabrics, to provide maximum durability & hold.

- Universal is suitable for use with all paints, and is perfect for the Trade Professional.
- Mohair give the ultimate finish to full & semi gloss enamels on smooth & semi smooth surfaces. Suitable for applying polyurethanes, epoxys, resins & fibreglass coatings.



601



633



606



645



588

DESCRIPTION	SIZE	VPN	MOQ	CTN QTY	BARCODE
UNIVERSAL 10mm Nap > ideal with all paints on smooth and semi-smooth surfaces	75mm	606	1pc	120pcs	9310590006063
	130mm	607	1pc	60pcs	9310590006070
	180mm	600	1pc	60pcs	9310590006001
	230mm	601	1pc	120pcs	9310590006018
	270mm	602	1pc	120pcs	9310590006025
	360mm	603	1pc	72pcs	9310590006032
	460mm	602-18	1pc	60pcs	9310590602180
MOHAIR 6mm Nap > ideal with any gloss enamel & polyurethane paints on smooth surfaces	75mm	629	1pc	144pcs	9310590006292
	130mm	645	1pc	72pcs	9310590006452
	180mm	632	1pc	72pcs	9310590006322
	230mm	633	1pc	144pcs	9310590006339
	270mm	634	1pc	144pcs	9310590006346
	360mm	634-14	1pc	72pcs	9310590634143
WOVEN POLYESTER 6mm SHORT Nap > ideal with water based paints gloss paints on smooth & semi-smooth surfaces.	230mm	588	1pc	144pcs	9310590005882
	270mm	589	1pc	144pcs	9310590005899

FEATURES:

- > Maximum durability & paint hold
- > Best quality fabric
- > Fast, smooth & even coverage on all surfaces
- > Good pick-up and release
- > Easy to clean and re-use
- > Thick Phenolic core



USE WITH OIL PAINTS

OLDFIELDS PREMIUM SHEEPSKIN ROLLERS

Ideal for slight textured finish. These rollers are made from high quality **100% Australian wool** to provide maximum durability and maximum hold.



69511



69611



69911

DESCRIPTION	SIZE	VPN	MOQ	CTN QTY	BARCODE
SHEEPSKIN ROLLER 10mm Nap > ideal for semi-smooth walls	270mm	69511	1pc	100pcs	9310590695113
	360mm	69514	1pc	50pcs	9310590695144
SHEEPSKIN ROLLER 15mm Nap > ideal for semi-smooth walls & ceilings	270mm	69611	1pc	100pcs	9311721696115
	360mm	69614	1pc	50pcs	9311721696146
SHEEPSKIN ROLLER 20mm Nap > ideal for walls, ceilings rendered & textured surfaces	270mm	69911	1pc	100pcs	9311721699116
	360mm	69914	1pc	50pcs	9311721699147

FEATURES:

- > 100% Pure Australian Wool
- > Maximum durability & paint hold
- > Excellent pick up & release with a slight textured finish
- > Easy to clean and re-usable



USE WITH ALL PAINTS

OLDFIELDS CLASSIC ROLLERS

Perfect for trade and handyman requirements. A wide variety of roller covers to suit all painting needs. A great quality polyester fabric throughout the range provides even coverage & smooth finish.

CORRUGATED ROLLER
Perfect for corrugated fences, roofs & sheds



688



731



703



701



705

DESCRIPTION	SIZE	VPN	MOQ	CTN QTY	BARCODE
ROUGH SURFACES 20mm Nap > All paints on rough and semi-rough surfaces	230mm	731	1pc	40pcs	9310590007312
	270mm	737	1pc	40pcs	9310590007374
FLAT & LOW SHEEN 12mm Nap > All paints on smooth and semi-smooth surfaces	180mm	702	1pc	6pcs	9310590007022
	230mm	703	1pc	54pcs	9310590007039
	3pk 230mm	703-3	1pc	18pcs	9310590070330
	270mm	703-270	1pc	54pcs	9310590703276
ALL PAINTS 10mm Nap > All paints on smooth and semi-smooth surfaces	360mm	703-360	1pc	6pcs	9310590703368
	75mm	697-75	1pc	120pcs	9310590697759
	130mm	697-130	1pc	60pcs	9310590697131
	180mm	700	1pc	120pcs	9310590007008
	230mm	701	1pc	60pcs	9310590007015
	3pk 230mm	701-3	1pc	20pcs	9310590070132
GLOSS PAINTS 6mm Nap > All paints on smooth surfaces	270mm	698	1pc	60pcs	9310590006988
	180mm	704	1pc	154pcs	9310590007046
	230mm	705	1pc	77pcs	9310590007053
FENCE & DECK ROLLER & FRAME	270mm	705-270	1pc	77pcs	9310590070521
	130mm	586	1pc	6pcs	9310590005868
FENCE & DECK ROLLER	130mm	586R	1pc	6pcs	9310590058611
CORRUGATED ROLLER FOAM	230mm	688	1pc	6pcs	9310590006889



703-3



586

FEATURES:

- > Good durability & paint hold
- > Fast, smooth & even coverage on all surfaces
- > Good pick-up and release
- > Easy to clean and re-usable



USE WITH ALL PAINTS

OLDFIELDS TEXTURED ROLLERS

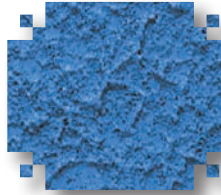

691



733



743

DESCRIPTION	SIZE	VPN	MOQ	CTN QTY	BARCODE
TEXTURE ROLLER COARSE Turquoise/Green Cover > Made from multi loop woven synthetic also called 'spaghetti sleeve' or 'goop loop'. > loops are approx. 8mm high	230mm	691	1pc	80pcs	9310590006919
	270mm	692	1pc	80pcs	9310590006926
TEXTURE ROLLER FINE Charcoal/Black Cover > Made from reticulated flexible polyester polyurethane foam 10mm thick > Aprox 8 cells per sq inch	230mm	733	1pc	50pcs	9310590007336
	270mm	734	1pc	80pcs	9310590007343
	460mm	734-18	1pc	80pcs	9310590734188
TEXTURE ROLLER SUPERFINE Charcoal/ Black Cover > Made from reticulated flexible polyester polyurethane foam 10mm thick > Aprox 30 cells per sq inch	230mm	743	1pc	80pcs	9310590007435
	270mm	744	1pc	80pcs	9310590007442

Ideal for decorative finishes and texture paints to create various stipple effects.

FEATURES:

- > Durable, hard wearing and maintains it's shape
- > Good pick-up and release for textured finishes.
- > Ideal for industrial applications.
- > Easy to clean and re-use



USE WITH
ALL PAINTS

ECONOMY & FOAM ROLLER COVERS



636



641

FOAM ROLLER COVER

> Perfect for use with full & semi gloss enamels for a super smooth mirror paint finish.

ECONOMY ROLLER COVER

An economical option with the economy roller cover. Available in multiple packs, it is suitable for use with all paints. The cover can be cleaned and re-used but is priced to be easily disposable.

FEATURES:

- > Synthetic
- > No seams for smooth finish
- > Good pick up and release

FEATURES:

- > Synthetic
- > Economical
- > Good pick up and release
- > Easy to clean



USE WITH OIL PAINTS



USE WITH ALL PAINTS

DESCRIPTION	SIZE	VPN	MOQ	CTN QTY	BARCODE
GENERAL PURPOSE ROLLER COVER 11mm NAP > Use with all paints > Economically Priced > Available in packs	230mm	641	1pc	6pcs	9310590006414
	270mm	642	1pc	6pcs	9310590006421
	4pk 230mm	641-4	1pc	6pcs	9310590064148
	4pk 270mm	642-4	1pc	6pcs	9310590064247
	10pk 230mm	641-10	1pc	6pcs	9310590064162
	10pk 270mm	642-10	1pc	6pcs	9310590064261
FOAM ROLLER COVER > Seamless > Ideal for a mirror paint finish	75mm	631	1pc	6pcs	9310590006315
	230mm	636	1pc	6pcs	9310590006360
	270mm	622	1pc	6pcs	9310590006223



Economy Covers available in multi packs

OLDFIELDS MINI ROLLERS

These convenient sized rollers are great for trim work such as windows and door frames.



686F



676R



624



584



686FR



582



623

DESCRIPTION	SIZE	VPN	MOQ	CTN QTY	BARCODE
NOOK & CRANNY FABRIC MINI ROLLER > for all paints	100mm 2pk	686R	1pc	6pcs	9310590068610
	100mm 10pk	676R	1pc	6pcs	9310590067613
	100mm BULK	686R-100	1pc	100 Box	9310590068658
NOOK & CRANNY MOHAIR MINI ROLLER > for gloss paints	100mm 2pk	686M	1pc	6pcs	9310590068641
	100mm 10pk	676M	1pc	6pcs	9310590067620
NOOK & CRANNY FOAM MINI ROLLER > for gloss paints	100mm 2pk	686F	1pc	6pcs	9310590068627
	100mm 10pk	676F	1pc	6pcs	9310590067637
NOOK & CRANNY VELOUR MINI ROLLER	100mm 2pk	686V	1pc	6pcs	9310590068634
NOOK & CRANNY FRAME MINI ROLLER	100mm	686FR	1pc	100pcs	9313290093883
NOOK & CRANNY SOFT GRIP FRAME	100mm	686SGFR	1pc	6pcs	9310590068672
NOOK & CRANNY FRAME & COVER MINI ROLLER	100mm	686	1pc	24pcs	9310590006865
MINI BABY FOAM ROLLER & FRAME > Red Handle	25mm 3pk	584	1pc	12pcs	9310590005844
	50mm	582	1pc	12pcs	9310590005820
	75mm	623	1pc	12pcs	9310590006230
MINI BABY FOAM REPLACEMENT COVER	50mm 2pk	583	1pc	12pcs	9310590005837
	75mm 2pk	624	1pc	12pcs	9310590006247

FEATURES:

- > Perfect for getting into the hard to reach areas
- > Easy application for a smooth finish
- > Easy to clean and re-use

USE WITH OIL PAINTS
Good with all paints.
Best with oil based paints and varnishes.



OLDFIELDS ROLLER KITS

A great value option to start off any painting project.

FEATURES:

- > Durable & easy cleaning
- > Economically priced



USE WITH
ALL PAINTS



683-INS



682



FEATURES:

- > Exceptional paint absorption
- > Durable & easy cleaning
- > Superfine finish



USE WITH
ALL PAINTS

686-160KIT



686KIT



DESCRIPTION	SIZE	VPN	MOQ	CTN QTY	BARCODE
CLASSIC ALL PURPOSE ROLLER KIT 3 PIECE 1 x Heavy duty tray 1 x Heavy duty frame 1 x Roller cover - All Paints Cover	230mm	685	1pc	10pcs	9310590006858
	270mm	683	1pc	6pcs	9310590006834
GENERAL PURPOSE ROLLER KIT 3 PIECE 1 x Tray 1 x Frame 1 x Economy Roller	230mm	682	1pc	12pcs	9310590006827
	270mm	683-INS	1pc	10pc	9310590683004
MINI PAINT ROLLER KIT ALL PURPOSE ROLLER KIT 4 PIECE 1 x Tray 1 x Frame 2 x Roller covers - All Paints Cover - Gloss Cover	100mm	686KIT	1pc	6pcs	9310590686128
	160mm	686-160KIT	1pc	6pcs	9310590686180
TRIM ROLLER KIT	75mm	3320	1pc	12pcs	9310590033205
TRAY LINERS	270mm	670TL	1pc	12pcs	9310590033205
	230mm	671-BLTL	1pc	15pcs	9313290093838

FEATURES:

- > Ideal for narrow areas, windows, mouldings & skirtings
- > Exceptional paint absorption
- > Light & fast
- > Durable & easy cleaning
- > Superfine finish



USE WITH
ALL PAINTS

3320



OLDFIELDS ROLLER FRAMES



PRO SERIES ROLLER FRAME

The strongest & most durable roller frame for the professional painter using stainless steel, solvent resistant 5 wire cage for best performance & a metal ferrule to prevent the handle splitting. Does not leave tracking marks on walls.



GENERAL PURPOSE ROLLER FRAME

> A good sturdy roller frame for simple projects.



CLASSIC ROLLER FRAME

> Ideal for all painting projects with all roller types. This durable frame will make painting easy with serious grip & spin mechanism to roll on paint.



End Cap for Adjustable Frame

662-End Cap



ADJUSTABLE U FRAME

Able to fit those extra large rollers. Ideal for painting large surfaces quickly. Perfect for flooring & concreting.

FEATURES:

- > Strong & durable
- > Easy to adjust
- > Lightweight
- > Rust resistant
- > Threaded handle to attach extension pole.



DESCRIPTION	SIZE	VPN	MOQ	CTN QTY	BARCODE
PRO SERIES ROLLER FRAME > Threaded Handle > Fits all standard extension poles	230mm	656	1pc	12pcs	9310590006568
	270mm	657	1pc	6pcs	9310590006575
CLASSIC ROLLER FRAME > Threaded Handle > Fits all standard extension poles	75mm	650	1pc	24pcs	9310590006506
	130mm	651	1pc	24pcs	9310590006513
	180mm	729	1pc	6pcs	9310590007299
	230mm	728	1pc	12pcs	9310590007282
	270mm	727	1pc	12pcs	9310590007275
QUICKWAY RED GENERAL PURPOSE ROLLER FRAME	230mm	726	1pc	40pc	9310590007268
	270mm	727Q	1pc	12pcs	9310590072716
ADJUSTABLE U FRAME	270mm to 460mm	662	1pc	12pcs	9310590006629
END CAP REPLACEMENT SET		662-END-CAP	1pc	1pc	9310590066289

OLDFIELDS EXTENSION POLES

Oldfields professional quality aluminium poles are made tough to last and ideal for use on large painting jobs. As well as being able to reach greater heights, they can also reduce the risk of roller splatter on the user. Safe, Fast & Clean.



> Larger diameter for comfort grip

> Strong & durable

> Pull-lock mechanism

> Light weight

The Oldfields extension poles won't slip or twist with positive locking in place. They come in a wide variety of sizes to ensure you can reach all places suitable for use with all rollers and can be used with screw tools.

DESCRIPTION	SIZE	VPN	MOQ	CTN QTY	BARCODE
ALUMINIUM EXTENSION POLES PRO SERIES > heavy duty > with metal thread	0.3m to 0.6m	761	1pc	6pcs	9310590007619
	0.6m to 1.2m	762	1pc	6pcs	9310590007626
	1.2m to 2.4m	764	1pc	6pcs	9310590007640
	1.8m to 3.6m	766	1pc	6pcs	9310590007664
COATED STEEL POLES > with metal thread	1.2m	770	1pc	6pcs	9310590007701
	1.1m to 2.0m	772	1pc	6pcs	9310590007725
WOODEN POLES > with metal thread	1.2m	660	1pc	6pcs	9310590006605
	1.8m	661	1pc	6pcs	9310590006612



766 764 762 761 661 772 770

OTHER APPLICATIONS



OLDFIELDS PAINT POTS

IDEAL FOR: Storing, mixing & transporting paint.



454
PLASTIC 600ml
With Brush Holder
(Brush not included)



459
METAL 4L



457
PLASTIC 4L
(Lid sold separately)

DESCRIPTION	SIZE	VPN	MOQ	CTN QTY	BARCODE
PLASTIC PAINT POT YELLOW with Brush Holder	600ml	454	1pc	24pcs	9310590004540
PLASTIC PAINT POT	4L	457	1pc	20pcs	9310590004571
PLASTIC PAINT POT LID	4L	458	1pc	20pcs	9310590004588
METAL PAINT POT	4L	459	1pc	24pcs	9310590004595

FEATURES:

- > Heavy Duty
- > Light Weight
- > Easy To Clean



USE WITH
ALL PAINTS

OLDFIELDS PAINTER'S BUCKETS



Save time & make painting easier with the painters bucket. Comes equipped with roller ramps allowing you to carry more paint than a standard tray.



678P

*Accessories not included



678345



677P



PAINTER'S TROLLEY
*Accessories not included

678TR



674P

FEATURES:

- > Heavy duty buckets
- > Durable design - does not bend
- > Holds a large amount of paint
- > Comes with lids for paint storage between jobs
- > Roller ramps make application easy
- > Bright Yellow in colour to stand out
- > Suitable for use with all paints
- > Easy to clean and re-use

DESCRIPTION	SIZE	VPN	MOQ	CTN QTY	BARCODE
PAINTER'S BUCKET with LID & RAMP	250mm 6L	674P	1pc	6pcs	9310590067446
	330mm 14L	677P	1pc	6pcs	9310590067781
	440mm 20L	678P	1pc	6pcs	9310590067880
PAINTER'S TROLLEY	440mm	678TR	1pc	6pcs	9310590067897
METAL ROLLER BUCKET PRO SERIES	300mm 345mm	678345	1pc	1pc	9310590678345



USE WITH ALL PAINTS

OLDFIELDS PAINT TRAYS



Versatile roller tray & paint bucket that can lay flat on the ground or be used to hook onto some ladders & scaffolding jobs. As well as being able to reach greater heights, they can also reduce the risk of roller splatter on the user. Safe, Fast & Clean.



673
(Accessories not included)

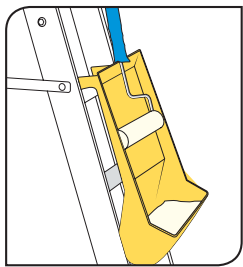

62890



670



671BL



686TRAY

DESCRIPTION	SIZE	VPN	MOQ	CTN QTY	BARCODE
HOODED ROLLER TRAY Pro Series	230mm 1.5L	62890	1pc	6pcs	9311721628901
	270mm 3L	673	1pc	6pcs	9310590006735
HEAVY DUTY PLASTIC ROLLER TRAY	270mm	670	1pc	6pcs	9310590006704
	320mm	669	1pc	6pcs	9310590006698
GENERAL PURPOSE ROLLER TRAY	110mm	686TRAY	1pc	24pcs	9310590068665
	160mm	686-160TRAY	1pc	24pcs	9310590686319
	230mm	671BL	1pc	6pcs	9310590067118

FEATURES:

- > Angled tray, easier to hook onto ladders
- > Sturdy design - does not bend
- > Deep wells to hold more paint
- > Heavy duty
- > Easy to clean



USE WITH
ALL PAINTS

OLDFIELDS SHEEPSKIN MITTS

IDEAL FOR Painting, rendering & polishing. The elastic cuff prevents wearer being dripped on & allow for a better fit.



697MITT



696MITT

FEATURES:

- > Lining to prevent soak through
- > 100% Pure Australian wool
- > Maximum durability
- > Maximum paint hold and release
- > Heavy duty & reusable



DESCRIPTION	SIZE	VPN	CTN QTY	BARCODE
SHEEPSKIN MITT	WITH THUMB	696MITT	100pcs	9310590069662
	WITH NO THUMB	697MITT	100pcs	9310590069761



USE WITH ALL PAINTS

OLDFIELDS DECKING APPLICATOR

IDEAL FOR: Easy application of decking oils & stains on outdoor timber decking.

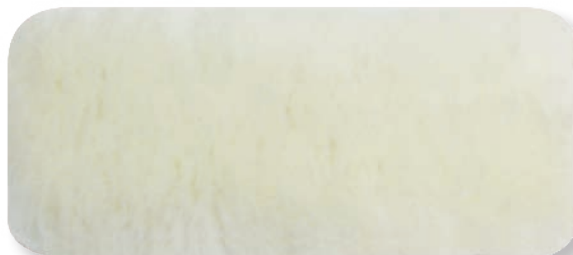

696PAD
(Includes pole)



FEATURES:

- > Easy to clean
- > 100% pure Australian wool
- > Fast, even application
- > Maximum varnish fold & release
- > Heavy duty & reusable



696SPARE



USE WITH
WOOD, STAINS &
VARNISHES

DESCRIPTION	SIZE	VPN	CTN QTY	BARCODE
DECKING APPLICATOR WITH POLE	230mm	696PAD	24pcs	9310590069631
DECKING APPLICATOR REPLACEMENT SOCK	230mm	696SPARE	105pcs	9310590069648

OLDFIELDS STRAIGHT LINE EDGER

IDEAL FOR: Fast & accurate straight lines around windows, doors & skirting boards.

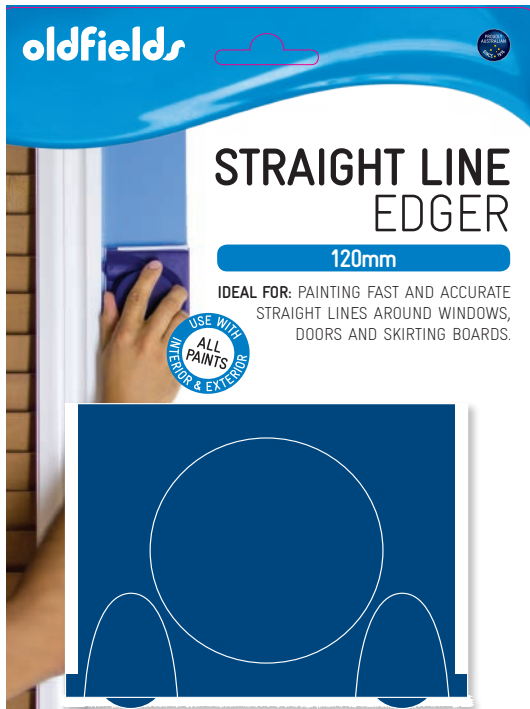

3330



3331

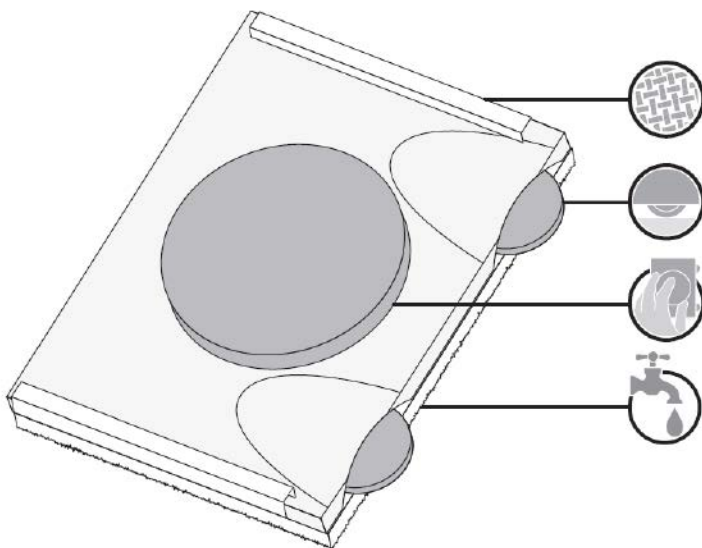

FEATURES:

- > Premium woven replacement pads
- > Guide wheels for straight line edging
- > Comfortable easy grip
- > Easy clean

DESCRIPTION	SIZE	VPN	CTN QTY	BARCODE
STRAIGHT LINE EDGER > Two wheel edger	120mm	3330	12pcs	9310590033304
REPLACEMENT PAD > 2 Pack		3331	10pcs	9310590033311



OLDFIELDS PAINT PADS

IDEAL FOR: A faster, lighter & easier substitute to paint rollers & brushes. Using professional woven fabric laminated to foam for a smooth, consistent paint finish & and an adjustable, non-slip swivel comfort grip handle to make painting easier in tight & awkward spaces.



3370



3371



FEATURES:

- › Swivel easy grip to reach any angle
- › Tear resistant fabric
- › Fits extension poles
- › Heavy Duty
- › Easy to clean



3350



DESCRIPTION	SIZE	VPN	CTN QTY	BARCODE
PAINT PAD SMALL	125mm	3340	10pcs	9310590033403
PAINT PAD SMALL REPLACEMENT PAD		3341	10pcs	9310590033410
PAINT PAD LARGE	180mm	3370	6pcs	9310590033700
PAINT PAD LARGE REPLACEMENT PAD		3371	12pcs	9310590033717
CORNER PAD		3350	6pcs	9310590033502



USE WITH
ALL PAINTS

OLDFIELDS WALLPAPER TOOLS

Everything you need to complete any wallpapering job.



469



862



433

DESCRIPTION	SIZE	VPN	MOQ	CTN QTY	BARCODE
WALLPAPER SMOOTHER › Smooths out wrinkles, seams & bubbles for smooth finish		862	1pc	12pcs	9310590008623
NOTCHED PLASTIC ADHESIVE SPREADER › Durable Plastic with 2 spreaders › 6 Different spacings to ensure even spread		469	1pc	12pcs	9310590004694
PAINT GUIDE & STRIAIGHT EDGE › Hold wallpaper in place while cutting › To keep paint where you want it › Multi tool to help get hard to reach corners	610mm	433	1pc	12pcs	9310590004335

FEATURES:

- › Easy to use & clean
- › Perfect for all wallpaper jobs
- › Heavy duty & reusable
- › Some items can be used for multiple paint application tasks

PROTECTION



OLDFIELDS COVER GRIP SAFETY DROP CLOTH

Patented, Slip Resistant Canvas Drop Cloth
Unique to the Market

FEATURES:



> Slip Resistant

Hold fast to floors, resists slipping on wood, tile, marble & granite floors.



> Lies Flat

Stays in place, conforming to the surface it is placed on. Works well even on stairs.



> Designed for Safety

Designed with thousands of rubberised traction dots to hold the cloth in place, for safety and peace of mind.

> Easy to clean

> Protects floors

> Available in 3 popular sizes



883P



882P



881P

DESCRIPTION	SIZE	VPN	MOQ	CTN QTY	BARCODE
COVER GRIP DROP CLOTH	12' x 3'6"	881P	1pc	8pcs	9313290089237
	5' x 8'	882P	1pc	8pcs	9313290089244
	8' x 10'	883P	1pc	4pcs	9313290089251

OLDFIELDS PAINTER'S DROP CLOTHS

IDEAL FOR: Protection against paint splatter, dust & dirt. Use to cover floors, carpets, furniture & equipment.

FEATURES:

- > Heavy duty cotton
- > Strong & reusable
- > Extra thick for added protection
- > Close weave for exceptional performance



870P



871P



872P



874P



873P



875P



876P

DESCRIPTION	SIZE	VPN	MOQ	CTN QTY	BARCODE
PAINTERS DROP CLOTHS > heavy duty cotton	3.66m x 2.74m (12'x9') Medium Room	870P	1pc	3pcs	9310590008708
	3.66m x 3.66m (12'x12') Medium Room	871P	1pc	3pcs	9310590008715
	3.66m x 4.58m (12'x15') Large Room	872P	1pc	2pcs	9310590008722
	3.66m x 5.5m (12'x18') Large Room	873P	1pc	2pcs	9310590008739
	3.66m x 1.52m (12'x5') Passage Way	874P	1pc	5pcs	9310590008746
	2.74m x 1.52m (9'x5') Small Room	875P	1pc	8pcs	9310590008753
	5.5m x 1.52m (18'x5') Passage Way	876P	1pc	4pcs	9310590008760
PLASTIC PROTECTION SHEET - LIGHT WEIGHT	3.6m x 2.7m (12'x9')	886	1pc	50pcs	9310590008869
PLASTIC PROTECTION SHEET - LIGHT WEIGHT	4 Pack	886-4	1pc	12pcs	93105900088649
PLASTIC PROTECTION SHEET - HEAVY DUTY	3.6m x 2.7m (12'x9')	889	1pc	20pcs	9310590008890

PLASTIC PROTECTION SHEETS

FEATURES

- > Water proof
- > Seamless & reusable
- > Heavy duty
- > Lightweight



886



889



886-4

OLDFIELDS PROTECTIVE GEAR

DISPOSABLE COVERALL WITH HOOD

Ideal for protection against paint, dust & dirt. Use when general painting, spray painting, timber sanding, cleaning, boat repairs & gardening.

> Comes in Medium, Large, X Large & XX Large.



88015

BAG OF RAGS

Ideal for staining, cleaning & paint spills.

> Soft, clean assorted sizes & fabrics.



822



823



824



825

DESCRIPTION	SIZE	VPN	MOQ	CTN QTY	BARCODE
BAG OF RAGS	1.5kg	88015	1pc	12pcs	9310590880151
DISPOSABLE COVERALLS	MEDIUM	822	1pc	12pcs	9310590008227
	LARGE	823	1pc	12pcs	9310590008234
	X LARGE	824	1pc	12pcs	9310590008241
	XX LARGE	825	1pc	12pcs	9310590008258

FEATURES:

- > Strong & tear resistant
- > Light weight
- > Elastic hood, cuffs & ankles provides added protection

OLDFIELDS MASKING PAPER

DESCRIPTION	SIZE	VPN	MOQ	CTN QTY	BARCODE
OLDFIELDS MASKING PAPER > 40gsm kraft paper > Use with hand masking machine which applies masking tape to the paper as it is dispensed	150mm	896	1pc	50 rolls carton	9310590008968
	150mm 3pk	896-3	1pc	20pcs	9310590089639
	300mm	897	1pc	25 rolls carton	9310590008975
	300mm 3pk	897-3	1pc	10pcs	9310590089738



897

896

FEATURES:

- > Create sharp lines
- > Pressure sensitive adhesive for safe release
- > Easily removed without leaving residue
- > A variety of strengths available

TOOLS



OLDFIELDS CAULKING GUNS

Finish off any sealing projects with precision and accuracy using a cleverly designed caulking gun. The caulking gun is ideal for producing quality professional edges, corners and joints.



**POLY/FIBREGLASS
CAULKING GUN SKELETON**

- > Polypropylene nylon & fibreglass.
- > "STOP DRIP" feature.
- > Ratched rod.

813FG



**STANDARD
CAULKING GUN SKELETON**

- > "STOP DRIP" feature.
- > Ladder hook & swivel handle.
- > Seal punch & spout cutter.

813IND



**INDUSTRIAL
CAULKING GUN**

- > Heavy duty
- > Ladder hook & swivel handle.

815



813

**HEAVY DUTY
CAULKING GUN SKELETON**

- The best quality & ideal for longterm & regular use.
- > Maximum durability & hold.
 - > "STOP DRIP" feature.
 - > Ladder hook & swivel handle.
 - > Seal punch & spout cutter.

DESCRIPTION	VPN	MOQ	CTN QTY	BARCODE
HEAVY DUTY CAULKING GUN	813	1pc	6pcs	9310590008135
POLY/FIBREGLASS CAULKING GUN	813FG	1pc	6pcs	93105900081312
CRAFTSMAN INDUSTRIAL CAULKING GUN	813IND	1pc	6pcs	93105900081329
CAULKING GUN SKELETON STANDARD	815	1pc	6pcs	9310590008159

OLDFIELDS PAINT SCRAPERS

THE PROFESSIONALS CHOICE

Premium quality scrapers are made to last with stainless steel blades, wooden handle & brass rivets & eyelets.



DESCRIPTION	SIZE	VPN	MOQ	CTN QTY	BARCODE
PAINT SCRAPER CRAFTSMAN 900 SERIES > ideal for removing paint, rust, wallpaper & putty	25mm	901	1pc	12pcs	9310590009019
	38mm	903	1pc	12pcs	9310590009033
	50mm	905	1pc	12pcs	9310590009057
	63mm	907	1pc	12pcs	9310590009071
	75mm	909	1pc	12pcs	9310590009095
	100mm	911	1pc	12pcs	9310590009118
	125mm	913	1pc	12pcs	9310590009132
COMBINATION TOOL > Multi purpose tool > Remove paint, putty, old caulking, nails, roller cleaning, spreading adhesives & can opening		917	1pc	12pcs	9310590009170
PUTTY KNIFE > Ideal for applying, spreading & removing putty & fillers to flat surfaces.		915	1pc	12pcs	9310590009156
FILLING BLADE CRAFTSMAN 900 SERIES	5cm	2062	1pc	12pcs	9310590020625
	8cm	2063	1pc	12pcs	9310590020632
	10cm	2064	1pc	12pcs	9310590020649
	12cm	2065	1pc	12pcs	9310590020656
	4pk	2067	1pc	10pcs	9310590020670



FEATURES:

- > Heavy duty for professional use
- > Strong & durable
- > High quality wooden handle
- > 3 Brass rivets & eyelets in each handle for additional strength
- > High quality flexible stainless steel
- > Easy to clean
- > Ideal for removing paint, rust, wallpaper putty

OLDFIELDS PAINT SCRAPERS - Soft Grip

Craftsman series carbon steel scrapers made with ergonomic non-slip plastic handle to make your project easier. Ideal for removing paint, rust, wallpaper & putty.



802

803

804

805

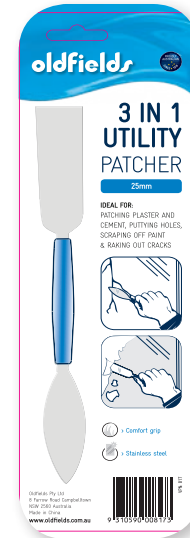

817



807

806

DESCRIPTION	SIZE	VPN	MOQ	CTN QTY	BARCODE
PAINT SCRAPER SOFT GRIP CRAFTSMAN 800 SERIES	38mm	802	1pc	10pcs	9310590008029
	50mm	803	1pc	10pcs	9310590008036
	75mm	804	1pc	10pcs	9310590008043
	100mm	805	1pc	10pcs	9310590008050
COMBINATION TOOL SOFT GRIP		807	1pc	10pcs	9310590008074
PUTTY KNIFE SOFT GRIP		806	1pc	10pcs	9310590008067
UTILITY PATCHER	8cm	817	1pc	12pcs	9310590008173

FEATURES:

- > Soft grip handle
- > Heavy duty
- > Strong & durable
- > High quality flexible carbon steel
- > Easy to clean
- > Ideal for removing paint, rust, wallpaper & putty

OLDFIELDS GENERAL PURPOSE PAINT SCRAPERS

A great all purpose scraper at a reasonable price and comes in a variety of sizes. Ideal for removing paint, rust, wallpaper & putty.



464

463

462

461



480

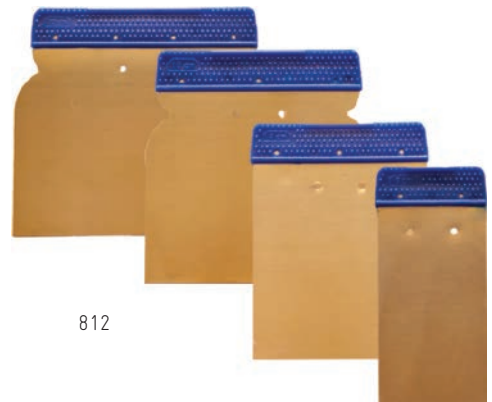

812

DESCRIPTION	SIZE	VPN	MOQ	CTN QTY	BARCODE
TRIANGLE SHAVE HOOK GENERAL PURPOSE		480	1pc	12pcs	9310590004809
FILLING BLADES GENERAL PURPOSE	(5cm, 8cm, 10cm, 12cm) 4pk	812	1pc	20pcs	9310590008128
PLASTIC SCRAPER GENERAL PURPOSE HOUSEMATE 460 SERIES > Soft flexible tip for smooth even finish > Heavy duty plastic	38mm	461	1pc	48pcs	9310590004618
	50mm	462	1pc	48pcs	9310590004625
	75mm	463	1pc	48pcs	9310590004632
	150mm	464	1pc	24pcs	9310590004649
	3pk 38mm, 50mm, 75mm	465	1pc	6pcs	9310590004656

FILLING BLADES

- > Stainless steel blade
- > No rusting
- > Plastic comfort grip
- > Can be used for multiple jobs

OLDFIELDS STRIPPING KNIVES



849



695

FEATURES:

- > Forged steel blades for lasting sharpness
- > Maximum strength & durability
- > Sharp flat & flat edge
- > Sharp edge for removing paint from glass
- > Flat edge for removing paper, floor tiles & ceramic tiles

OLDFIELDS SAFETY KNIVES

SNAP BLADE KNIFE & BLADES



818



828



819



829

FEATURES:

- > Maximum strength & durability
- > Ideal for wallpaper trimming, light duty cutting of paper, vinyl sheets, leather & rubber
- > Comes with 2 spare blades

DESCRIPTION	SIZE	VPN	MOQ	CTN QTY	BARCODE
BIG BLADE STRIPPING KNIFE	100mm	849	1pc	5pcs	9310590008494
BLADE STRIPPING KNIFE	100mm 5pk	695	1pc	10pcs	9310590006957
SNAP BLADE KNIFE	LARGE Maxi Cutter	818	1pc	6pcs	9310590008180
	SMALL Mini Cutter	819	1pc	24pcs	9310590008197
SNAP BLADES 5 Pack	LARGE Maxi Cutter	828	1pc	12pcs	9310590008289
SNAP BLADES 5 Pack	SMALL Mini Cutter	829	1pc	50pc	9310590008296

LINBIDE HEAVY DUTY SCRAPERS

Made with the highest quality steel handle and tungsten carbide blades. A precision tool with a reversible blade that can be used as either a push or pull scraper and are ideal for scraping timber skirting boards prior to re-painting.

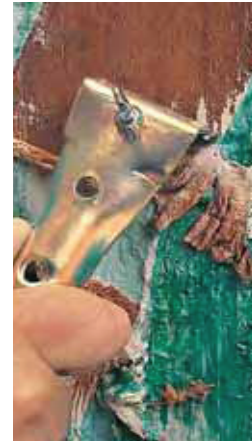

GP50



GPBLADE50



GP502



GP14



GPBLAD14



DESCRIPTION	SIZE	VPN	CTN QTY	BARCODE	
LINBIDE GENERAL SCRAPER > This tool will scrape paint, glue, timber & varnish with or without a flame.	SCRAPER & BLADE	50mm	GP50	10 pcs	9416206430007
	2 PACK BLADES	50mm	GPB502	1pc	9416206430083
	5 PACK BLADES	50mm	GPBLADE50	1pc	9416206430021
LINBIDE CORNER SCRAPER > Scraping both sides of a 90° corner is overcome with the clever design of this heavy duty tool. Great for removing window putty.	SCRAPER & BLADE		GP14	10pcs	9416206430014
	5 PACK BLADES		GPBLAD14	1pc	9416206430038

FEATURES:

- > Maximum strength & durability
- > Solid tungsten carbide blades
- > Reversible & replaceable blades

OLDFIELDS SAFETY SCRAPERS



850



856



855C



HANDY WINDOW SCRAPER
WITH BLADE

CAUTION
Use with care.
Use Oldfields replacement blades.
(Cat. No. 830)



832



830

DESCRIPTION	SIZE	VPN	CTN QTY	BARCODE	
SAFETY SCRAPER & 1 BLADE > Single edged blade > Push button action > Made in the USA > Ideal for removing paint from various areas		850	1pc	1pc	9310590008500
SCRAPER BLADES 5pk	5 pack	855C	1pc	20pcs	9310590085518
SCRAPER BLADES 100pk	100pk	856	1pc	1pc	9310590008562
WINDOW SCRAPER > Strong plastic > Ideal for removing paint from windows > Comes with a spare blade		832	1pc	12pcs	9310590008326
UTILITY BLADES 5pk	5 Pack	830	1pc	12pcs	9310590008302

FEATURES:

- > Maximum strength & durability
- > Ideal for removing paint from various surfaces
- > Replaceable blades

OLDFIELDS TOOLS PREPARATION

Preparation is the most important step in achieving a great paint finish. Scraping, sanding or brushing away previous paint and smoothing the paint area is essential to create professional paint finish.



844

POLE SANDER

With threaded adaptor, suitable for use with all Oldfields extension poles.



858

857

859SC

DESCRIPTION	SIZE	VPN	MOQ	CTN QTY	BARCODE
HEAVY DUTY WIRE BRUSH	3 x 19 Row	858	1pc	12pcs	9310590008586
GENERAL PURPOSE WIRE BRUSH	4x15 Row	857	1pc	6pcs	9310590008579
WIRE BRUSH WITH SCRAPER	4 x 19 Row	859SC	1pc	12pcs	9310590018592
POLE SANDER PRO SERIES		844	1pc	1pc	9310590008449

OLDFIELDS TOOLS MIX, WACK, CLEAN & PADDLE



PAINT PADDLES WOODEN
Your company logo can be printed onto wooden paint paddles. Minimum order of 1000 units.

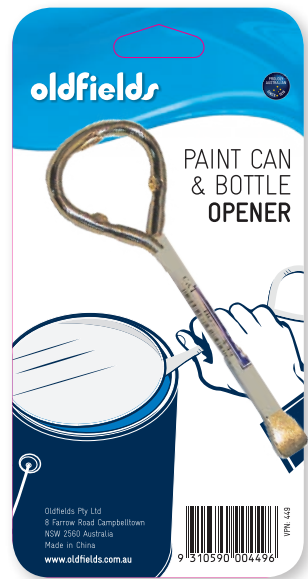

DESCRIPTION	SIZE	VPN	MOQ	CTN QTY	BARCODE
UNIVERSAL PLASTIC PAINT MIXER > Heavy duty > Can be used on Drills	20L	446	1pc	12pcs	9310590004465
UNIVERSAL PLASTIC PAINT MIXER > Heavy duty > Can be used on drills	1-4L	447	1pc	12pcs	9310590004472
NYLON PLATE PAINT PADDLE > Heavy duty	2-6L	466	1pc	12pcs	9310590004663
PLASTIC PAINT PADDLE > Heavy duty durable plastic > Light weight	6L	453	1pc	12pcs	9310590004533
WOODEN PAINT PADDLE	10L	452	1pc	1pc	9310590004526
WOODEN PAINT PADDLE	4L	450	1pc	1pc	9310590004502
PAINT CAN & BOTTLE OPENER		449	1pc	12pcs	9310590004496
ROLLER CLEANER WIRE > Ideal for scraping excess paint off rollers before washing		689-W	1pc	30pcs	9310590016895
ROLLER CLEANER SPIN > Efficient way to clean rollers to ensure long life		689-T	1pc	5pcs	9310590006896



SHEDS & STORAGE



TRECO STORAGE SOLUTIONS SINCE 1967

Superior quality range of easy to assemble storage products.
They are the toughest, most attractive Australian made garden sheds.

FEATURES OF ALL OLDFIELDS SHEDS:

- > 20 Year warranty. Easy to assemble.
- > Modular structure. Flexibility in build sizes.
- > Corrosion protection.
- > Standard 0.30mm gauge steel used. (Minimum 0.25mm).
- > Hot dipped galvanised for higher corrosion resistance.
- > Full structure frames with mid wall bracing for additional strength.
- > Wrap around corners for added strength and weather protection.
- > Ventilated gable roof allows circulation & reduced condensation build up.
- > Entry & Exit ramps, reinforced to withstand heavy items.
- > Design allows for replacement of panels any time in case of damage.
- > Extra Wall Height of 2m available to increase usage flexibility (Standard is 1.78m).
- > Variety of door options available. Sliding doors, single and double hinged doors & side access doors to suit all customer needs.



EASY TO
ASSEMBLE



STRONG &
RELIABLE



MADE IN
AUSTRALIA



20 YEAR
WARRANTY

OPTIONAL EXTRAS

Skylights: Polycarbonate panels that are easy to install on any garden shed by replacing a roof panel.

Window: Perspex and can be fitted easily to any garden shed to let in extra light and ventilation.

Corner Shelves: Galvanised Steel available in single units or sets of 2 or 3 and fitted in any shed.

Wall Length Shelves: MDF timber with steel reinforcing. Wall shelves go along the back wall of any shed in 1, 2 or 3 tiers.

Door Glides: Supplied in sets of 4.



CHOOSING A SHED

STYLE & SIZE: Always choose the biggest shed that will fit all of your items and fit in the desired location. Measure the space correctly and consider obstructions that may interfere with the construction of the shed, such as tree branches, other buildings, easements and the proximity to your neighbour's fence.

COLOUR: When considering colour, although personal preference is important, also consider choosing a colour that compliments your existing fence as well as trim colours on your fascia's and window frames of your house. If selecting a light colour link zinc, will sun reflection be an issue in the back yard. Please note that some local authorities do not allow zinc sheds because of this reason.

HOW TO ORDER: When selecting a shed please quote the model number, colour and the type of door, not forgetting to add any accessories you need.

DISCLAIMER: All sized quoted in this catalogue are nominal and usually refer to the roof size. Please check the catalogue for these dimensions. We have reproduced the colours as accurately as possible however we recommend you check an actual sample usually available from an authorised Oldfields dealer. Most accessories and/or props used in this brochure are not included with the product. Specifications in this catalogue may change without notice. We reserve the right to correct printing errors.

GABLE ROOF SHEDS

The Gable Roof is the most traditional Australian shed. It come standard with sliding doors, which are ideal where space is limited. Some models are also available in single or double hinged doors and 2 meter wall height as optional extras.

Zinc, Smooth Cream, Mist Green, Slate Gray & All Slate Gray colours available.

FEATURES:

- > The sloped roof of the gable shed diverts rain, sleet & snow away from the shed, preventing heavy build up on the roof.
- > A perfect ascetically appealing and functional addition to any backyard.
- > The additional height allows for better circulation and air flow inside the shed.
- > The gable allows for more headroom inside and more space to store taller items.
- > Used to store most outdoor items, lawn mowers, wheel barrows, pool equipment.



Model No.	Specifications			Sliding Doors Door Opening Height x Width (M)	Hinged Doors Door Opening Height x Width (M)
	Roof & Slab (Width x Depth) (M)	Shed Base (Width x Depth) (M)	Skillion Roof Height (M)		
63	1.83m x 0.92m	1.71m x 0.82m	1.93m	1.70 x 0.69	1.73 x 0.75
64	1.83m x 1.23m	1.71m x 1.13m		1.70 x 0.69	1.73 x 0.75
65	1.83m x 1.54m	1.71m x 1.44m		1.70 x 0.69	1.73 x 0.75
66	1.83m x 1.85m	1.71m x 1.75m		1.70 x 0.69	1.73 x 0.75
67	1.83m x 2.16m	1.71m x 2.06m		1.70 x 0.69	1.73 x 0.75
68	1.83m x 2.47m	1.71m x 2.37m		1.70 x 0.69	1.73 x 0.75
69	1.83m x 2.78m	1.71m x 2.68m		1.70 x 0.69	1.73 x 0.75
613	1.83m x 4.02m	1.71m x 3.92m		1.70 x 0.69	1.73 x 0.75
83	2.45m x 0.92m	2.33m x 0.82m		1.98m	1.70 x 1.04
84	2.45m x 1.23m	2.33m x 1.13m	1.70 x 1.04		1.73 x 0.75
85	2.45m x 1.54m	2.33m x 1.44m	1.70 x 1.04		1.73 x 0.75
86	2.45m x 1.85m	2.33m x 1.75m	1.70 x 1.04		1.73 x 0.75
87	2.45m x 2.16m	2.33m x 2.06m	1.70 x 1.04		1.73 x 0.75
88	2.45m x 2.47m	2.33m x 2.37m	1.70 x 1.04		1.73 x 0.75
89	2.45m x 2.78m	2.33m x 2.68m	1.70 x 1.04		1.73 x 0.75
813	2.45m x 4.02m	2.33m x 3.92m	1.70 x 1.04		1.73 x 0.75
815	2.45m x 4.64m	2.33m x 4.54m	1.70 x 1.04		1.73 x 0.75
819	2.45m x 5.88m	2.33m x 5.78m	1.70 x 1.04	1.73 x 0.75	
103	3.07m x 0.92m	2.95m x 0.82m	2.03m	1.70 x 1.38	1.73 x 1.50**
104	3.07m x 1.23m	2.95m x 1.13m		1.70 x 1.38	1.73 x 1.50**
105	3.07m x 1.54m	2.95m x 1.44m		1.70 x 1.38	1.73 x 1.50**
106	3.07m x 1.85m	2.95m x 1.75m		1.70 x 1.38	1.73 x 1.50**
107	3.07m x 2.16m	2.95m x 2.06m		1.70 x 1.38	1.73 x 1.50**
108	3.07m x 2.47m	2.95m x 2.37m		1.70 x 1.38	1.73 x 1.50**
109	3.07m x 2.78m	2.95m x 2.68m		1.70 x 1.38	1.73 x 1.50**
1010	3.07m x 3.09m	2.95m x 2.99m		1.70 x 1.38	1.73 x 1.50**
1013	3.07m x 4.02m	2.95m x 3.92m		1.70 x 1.38	1.73 x 1.50**
1015	3.07m x 4.64m	2.95m x 4.54m		1.70 x 1.38	1.73 x 1.50**
1019	3.07m x 5.88m	2.95m x 5.78m	1.70 x 1.38	1.73 x 1.50**	

** Double Hinged Door dimensions



EXTRA HEIGHT / WORKSHOP SHEDS

The gable roof Workshop shed is ideal for those who require the ultimate extra height storage shed. It come standard with sliding doors, which are ideal where space is limited. Some models are also available in single or double hinged doors and 2 meter wall height as optional extras. A personal access door can be added.

Zinc, Smooth Cream, Mist Green, Slate Gray & All Slate Gray colours available.

FEATURES:

- > The sloped roof of the gable shed diverts rain, sleet & snow away from the shed, preventing heavy build up on the roof.
- > A perfect ascetically appealing and functional addition to any backyard.
- > The additional height allows for better circulation and air flow inside the shed.
- > The extra height gable allows for more headroom inside and more space to store taller items.



Model No.	Specifications				Sliding Doors Door Opening Height x Width (M)	Hinged Doors Door Opening Height x Width (M)
	Roof & Slab (Width x Depth) (M)	Shed Base (Width x Depth) (M)	Skillion Roof Height (M)	Wall Height (M)		
832	2.45m x 0.92m	2.33m x 0.82m	2.2m		1.92 x 1.04	1.95 x 0.75
842	2.45m x 1.23m	2.33m x 1.13m			1.92 x 1.04	1.95 x 0.75
852	2.45m x 1.54m	2.33m x 1.44m			1.92 x 1.04	1.95 x 0.75
862	2.45m x 1.85m	2.33m x 1.75m			1.92 x 1.04	1.95 x 0.75
872	2.45m x 2.16m	2.33m x 2.06m			1.92 x 1.04	1.95 x 0.75
882	2.45m x 2.47m	2.33m x 2.37m			1.92 x 1.04	1.95 x 0.75
892	2.45m x 2.78m	2.33m x 2.68m			1.92 x 1.04	1.95 x 0.75
8132	2.45m x 4.02m	2.33m x 3.92m			1.92 x 1.04	1.95 x 0.75
8152	2.45m x 4.64m	2.33m x 4.54m			1.92 x 0.95	1.95 x 0.75
8192	2.45m x 5.88m	2.33m x 5.78m			1.92 x 0.95	1.95 x 0.75
1032	3.07m x 0.92m	2.95m x 0.82m	2.25m	2m	1.92 x 1.38	1.95 x 1.5
1042	3.07m x 1.23m	2.95m x 1.13m			1.92 x 1.38	1.95 x 1.5
1052	3.07m x 1.54m	2.95m x 1.44m			1.92 x 1.38	1.95 x 1.5
1062	3.07m x 1.85m	2.95m x 1.75m			1.92 x 1.38	1.95 x 1.5
1072	3.07m x 2.16m	2.95m x 2.06m			1.92 x 1.38	1.95 x 1.5
1082	3.07m x 2.47m	2.95m x 2.37m			1.92 x 1.38	1.95 x 1.5
1092	3.07m x 2.78m	2.95m x 2.68m			1.92 x 1.38	1.95 x 1.5
10102	3.07m x 3.09m	2.95m x 2.99m			1.92 x 1.38	1.95 x 1.5
10132	3.07m x 4.02m	2.95m x 3.92m			1.92 x 1.38	1.95 x 1.5
10152	3.07m x 4.64m	2.95m x 4.54m			1.92 x 1.29	1.95 x 1.5
10192	3.07m x 5.88m	2.95m x 5.78m	1.92 x 1.29	1.95 x 1.5		



UTILITY SHEDS

The Utility shed is an economical and functional way to store your vehicle, boat, bikes or trailer. The roomy home garage or workshop has ample space for circulation space for construction, maintenance tasks or the serious handyman. The double hinged doors has an opening of 2.6m with an added skylight for additional natural light. A personal access door can be added.

Smooth Cream, Mist Green & All Slate Gray colours available.

FEATURES:

- > An economical and functional way to store your vehicle, boat, bikes or trailer.
- > An affordable and roomy home garage or workshop space.
- > Ample room for circulation space for construction, maintenance tasks or the serious handyman.
- > Extra wide door opening or 2.6m with an added skylight. A personal access door can be added.
- > Extra high walls available to allow a 4 wheel drive or boat to fit.

Model No.	Specifications				Double Hinged Doors Opening Height x Width (M)
	Roof & Slab (Width x Depth) (M)	Shed Base (Width x Depth) (M)	Skillion Roof Height (M)	Wall Height (M)	
1013UT	3.07m x 4.02m	2.95m x 3.92m	2.03	1.78	1.73 x 2.60
1013UT2	3.07m x 4.02m	2.95m x 3.92m	2.25	2	1.95 x 2.60
1015UT	3.07m x 4.65m	2.95m x 4.55m	2.03	1.78	1.73 x 2.60
1015UT2	3.07m x 4.65m	2.95m x 4.55m	2.25	2	1.95 x 2.60
1019UT	3.07m x 5.88m	2.95m x 5.78m	2.03	1.78	1.73 x 2.60
1019UT2	3.07m x 5.88m	2.95m x 5.78m	2.25	2	1.95 x 2.60
1019UTSD*	3.07m x 5.88m	2.95m x 5.78m	2.03	1.78	1.73 x 2.60
1019UT2SD*	3.07m x 5.88m	2.95m x 5.78m	2.25	2	1.95 x 2.60

* Comes standard with a single hinged side door



STORE SMART & FLAT ROOF SHEDS

The Store Smart shed is an ideal choice when space is limited but storage is needed. Perfect for high density areas, under eaves, within a garage or in a carpark.

Zinc, Smooth Cream, Mist Green & Slate Gray colours available.



FEATURES:

- > Compact and versatile in size and style flat roof sheds are a great storage solution when there is limited space.
- > Has great depth to be able to store basic household items.
- > Perfect for high density areas especially under eaves, within garages or in carparks or unit complexes.
- > Compact in design to ensure they are easy to assemble and relocate if required.



Model No.	Specifications				
	Roof & Slab (Width x Depth) (M)	Shed Base (Width x Depth) (M)	Skillion Roof Height (M)	Wall Height (M)	Sliding Doors Door Opening Height x Width (M)
TRSC54FHD2 (Smooth Cream Only)	1.54m x 1.23m	1.37m x 1.12m	Flat Roof	2	1.73 x 0.65
TRMGSC64HD2 (Mist Green Only)	1.54m x 1.23m	1.37m x 1.12m	Gable Roof	2	1.73 x 0.65
63F **	1.84m x 0.92m	1.71m x 0.82m	1.8	1.78	1.70 x 0.69
83F2	2.46m x 0.92m	2.33m x 0.82m	2.02	2	1.92 x 1.04
103F2	3.08m x 0.92m	2.95m x 0.82m			1.92 x 1.38
65F (Smooth Cream Only)	1.84m x 1.54m	1.71m x 1.44m	1.8	1.78	1.70 x 0.69
85F (Smooth Cream Only)	2.46m x 1.54m	2.33m x 1.44m			1.92 x 1.04
105F (Smooth Cream Only)	3.08m x 1.54m	2.95m x 1.44m			1.92 x 1.38

** 63F comes standard with a single shelf S61

SKILLION ROOF SHEDS

The Skillion roof shed is a perfect solution for when space is limited. The Depth gives the opportunity to store basic household items such as lawn movers, bikes, pool items, etc.

Smooth Cream & Mist Green colours available.



FEATURES:

- > A practical and functional structure for any size property.
- > Limited space storage solution with great depth to be able to store basic household items.
- > Perfect for high density areas especially under eaves, within garages or in carparks.
- > The pitch of the roof delivers strong and clean ascetic appeal.
- > The skillion roof ensures there are fewer drainage problems when compared to flat roofs.



Model No.	Specifications				Sliding Doors Door Opening Height x Width (M)	Hinged Doors Door Opening Height x Width (M)
	Roof & Slab (Width x Depth) (M)	Shed Base (Width x Depth) (M)	Skillion Roof Height (M)	Wall Height (M)		
64LT	1.84m x 1.23m	1.71m x 1.13m	1.98	1.78	NA	1.73 x 0.65
84LT	2.46m x 1.23m	2.33m x 1.13m				
65LT	1.84m x 1.54m	1.71m x 1.44m				
85LT	2.46m x 1.54m	2.33m x 1.44m	2.03			
64BS	1.84m x 1.23m	1.71m x 1.13m	1.42	1.23	1.14 x 0.69	NA
64B	1.84m x 1.23m	1.71m x 1.13m	1.98	1.78	1.70 x 0.69	
84BS	2.46m x 1.23m	2.33m x 1.13m			1.70 x 1.04	

SCAFFOLDING



SCAFFOLDING MADE EASY ASK THE EXPERTS

Oldfields has over 25 years scaffolding experience in manufacturing and supply of aluminium scaffolding and offers a complete range of lightweight scaffold products including aluminium and fibreglass scaffold for commercial and domestic use.

FEATURES OF ALL OLDFIELDS SCAFFOLDS:

- > Australia's leading manufacturer of aluminium scaffold towers.
- > Australian Designed.
- > Complaint with Australian and New Zealand standards.
- > Oldfields quality assured.

CONFIGURATIONS AVAILABLE - ALUMINIUM ZIPPY SCAFFOLD



BASE UNIT
Platform Height: 1.6m
Reach Height: 3.6m



BASE UNIT & GUARD RAIL PACK
Platform Height: 1.9m
Reach Height: 3.9m



BASE UNIT & GUARD RAIL PACK WITH 1 x 1M EXTENSION
Platform Height: 2.9m
Reach Height: 4.9m

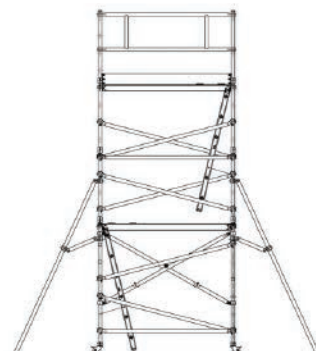

BASE UNIT & GUARD RAIL PACK WITH 2 x 1M EXTENSIONS
Platform Height: 3.9m
Reach Height: 5.9m

OTHER SCAFFOLDING AVAILABLE



ALUMINIUM TOWER - PRO SERIES
Providing a robust, versatile mobile or static work platform.



ALUMINIUM TOWER - 2600 SERIES
The most widely used mobile tower in the Australian Hire Industry.



FIBREGLASS TOWER - 2600 SERIES
Surprising affordability combined with exceptional safety, makes our range of fibreglass a suitable alternative for electrical applications.



ALUMINIUM SYSTEM SCAFFOLDING
The most versatile scaffold money can buy. Compatible with the 2600 series decks.

MAINTENANCE & SAFETY TIPS

BASIC MAINTENANCE RULES

1. Take good care of the scaffold. The equipment should be kept clean, especially joints and moving parts. Components should fit together easily without the use of force.
2. All working parts should be lightly lubricated with light machine oil. For example, brace spring bolts, stabiliser / outrigger bolted connections, thread on castor leg adjustment.
3. Do not let parts fall to the ground. Such abuse may damage the equipment and reduce its load capacity or render it unserviceable.
4. Never modify the scaffold components without authorisation from the manufacturer.

BASIC SAFETY RULES

<http://www.oldfields.com.au/scaffolding/basic-safety-rules>

ASSEMBLY INSTRUCTIONS

<http://www.oldfields.com.au/scaffolding/assembly-instructions>

ZIPPY-SCAFF ALUMINIUM

LIGHT DUTY FOLDABLE SCAFFOLD - Quality mobile working platform designed for commercial and DIY use.

ZippyScaff foldable aluminium scaffold is an extremely versatile folding scaffold built with different trades in mind, including decorators, electricians, insulation contractors, plasterers and sign writers. Movement is easy, when folded up it can be wheeled through a standard doorway. Ready for use in seconds, it can also act as a trolley for moving equipment around the home, office, factory or work site. Alternate working heights can easily be achieved in seconds by adjusting the working platform.

FEATURES:

- > Australian Designed
- > Easy to assemble
- > Lightweight
- > Compact & Portable
- > Working load rated to 225kg
- > Foldable easy to erect and dismantle in seconds
- > Built-in ladder access
- > Adjustable deck heights from 0.4m – 1.9m
- > Deck assembly manufactured with slip resistant plywood

SPECIFICATIONS:

- > Base Unit (Overall): 1.96m Long x 0.74m Wide x 1.96m High
 - > Standing Heights: 0.4m/0.9m/1.2m/1.9m*/2.9m/8.39m
 - > Working load (Max): 225kg
 - > Weights: Base Unit 50kg (includes deck)
- Guardrail Extensions Pack 35kg
 Extension pack with Outriggers required as per AS/NZS 1576
 * AS/NZ1576 requires that all single width towers be fitted with outriggers when platform height is at 1.9meters and above.

Item Code	Description
SZIPPYMKII	Adjustable scaffold with Hatch deck + horizontal brace
ZIPPYBBEXTNPK	Guardrail Extension Pack with 2 Outriggers



BASE UNIT & GUARDRAIL EXTENSION PACK.
(OUTRIGGERS NOT SHOWN FOR CLARITY)



BASE UNIT

TECHNICAL FEATURES

ALUMINIUM ZIPPY SCAFF

- Light Duty Rated SWL – 225kgs
- AS/NZS 1576.3-1995 Compliant
- Plant Design Registered

EASY TO ASSEMBLE



ZIPPY-SCAFF FIBREGLASS

LIGHT DUTY FOLDABLE SCAFFOLD - Fibreglass scaffold is ideal for working where electrical safety is paramount, a viable alternative to aluminium.

When electrical safety matters. Ideal for substations, computer rooms, construction sites and mines. Built with different trades in mind, Zippy-Scaff also provides a versatile access solution to trades such as decorators, electricians, insulation contractors, plasterers and sign writers. Ready for use in seconds, it can also act as a trolley for moving equipment around the home, office, factory or work site. Alternative working heights can easily be achieved in seconds by adjusting the working platform.

FEATURES:

- > Resistant to corrosion
- > Lightweight & easy to handle
- > Compact & portable
- > Foldable, east to erect and dismantle in seconds
- > Bright visible colour - Orange
- > Adjustable heights 0.4m – 1.9m
- > Ribbed Transom Tube
- > Easy to assemble with built in ladder

SPECIFICATIONS:

- > Base Unit (Overall): 1.96m Long x 0.74m Wide x 1.96m High
- > Standing Heights: 0.4m/ 0.9m/ 1.2m/ 1.9m*
- > Working load (Max): 225kg
- > Weights: Base Unit 42kg (includes deck)

Guardrail Extensions Pack 25kg

Extension pack with Outriggers required as per AS/NZS 1576

* AS/NZ1576 requires that all single width towers be fitted with outriggers when platform height is at 1.9meters and above.



BASE UNIT & GUARDRAIL EXTENSION PACK.
(OUTRIGGERS NOT SHOWN FOR CLARITY)

Item Code	Description
F-FSHA02	Adjustable scaffold with Hatch deck + Horizontal brace
F-FSXP2	Guardrail Extension Pack with 2 Outriggers



BASE UNIT

EASY TO ASSEMBLE

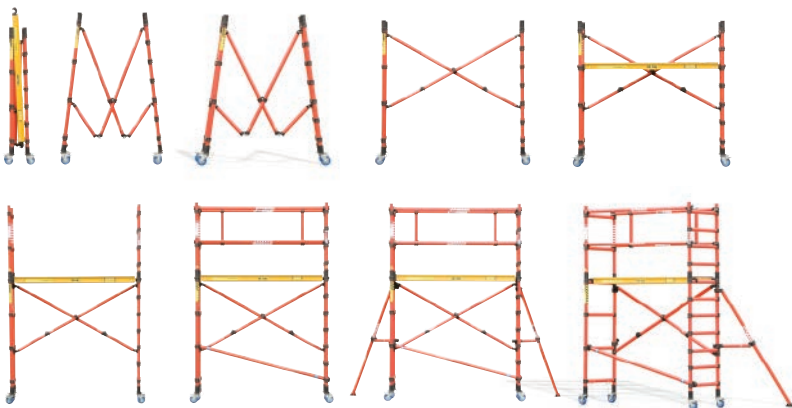

TECHNICAL FEATURES

FIBREGLASS ZIPPY SCAFF

- NATA Tested AS1931.1 and AS1931.2
- 5kV DC Insulation Resistance
- 110kV AC High Voltage Withstand
- 220kV AC High Voltage Withstand
- 80kV DC High Voltage Withstand
- Light Duty Rated SWL – 225kgs
- AS/NZS 1576.3-1995 Compliant
- Plant Design Registered with Work Cover NSW

LIGHT DUTY MINI FOLDABLE SCAFFOLD

Quality mobile working platform designed for commercial and DIY use.

The Mini ZippyScaff foldable aluminium scaffold is an extremely versatile folding scaffold designed with providing access to smaller areas. Built with different trades in mind, including decorators, electricians, insulation contractors, plasterers and sign writers. Movement is easy, when folded up it can be wheeled through a standard doorway. Ready for use in seconds, it can also act as a trolley for moving equipment around the home, office, factory or work site. Alternate working heights can easily be achieved in seconds by adjusting the working platform.

FEATURES:

- > Australian Designed
- > Easy to assemble
- > Lightweight
- > Compact & Portable
- > Working load rated to 225kg
- > Foldable easy to erect and dismantle in seconds
- > Built-in ladder access
- > Adjustable deck heights from 0.4m – 1.5m
- > Deck assembly manufactured with slip resistant plywood

SPECIFICATIONS:

- > Base Unit (Overall): 1.6m Long x 0.74m Wide x 1.6m High
- Standing Heights: 0.4m/ 0.7m/ 1.1m/ 1.5m*
- Working load (Max): 225kg
- Weights: Base Unit 345kg (includes deck)

Guardrail Extensions Pack 16kg

Extension pack with Outriggers required as per AS/NZS 1576

* AS/NZ1576 states that all single width towers require outriggers when platform height is at 1.9meters and above.

Item Code	Description
AL-FSHA-M	Adjustable scaffold with Hatch deck + horizontal brace
AL-FSXP-M	Guardrail Extension Pack with 2 Outriggers



BASE UNIT & GUARDRAIL EXTENSION PACK.
(OUTRIGGERS NOT SHOWN FOR CLARITY)



BASE UNIT

TECHNICAL FEATURES

ALUMINIUM ZIPPY SCAFF MINI

- Light Duty Rated SWL – 225kgs
- AS/NZS 1576.3-1995 Compliant
- Plant Design Registered with Work Cover NSW

EASY TO ASSEMBLE

(Diagram shows Aluminium Zippy)



OUR PROMISE TO YOU



- › Oldfields ensures we have the best sales representation & call centre team to assist with any queries, on time deliveries & easier ordering that will save you time & money.

Call 1300 306 888



- › For over 100 years Oldfields has been dedicated to developing & designing the best painting products in the market. Every product is designed for Quality and Excellent performance capabilities for an exceptional finish.



- › Oldfields ensures the right product offer in the best packaging with the right amount of product information & usage tips to make painting faster & easier.

Make Sure It's An Oldfields!



QUALITY SERVICE SINCE 1916

Address: 8 Farrow Road, Campbelltown, NSW, 2560

Website: www.oldfields.com.au

Email: sales@oldfields.com.au

Customer Service: 1300 306 888

oldfields